



Construction

Close-coupled self-priming shallow-well pump with built-in ejector.

A high-quality pump for domestic water supply. Designed with environmental considerations, featuring a stainless steel casing.

Applications

For drawing water out of a well.

For lifting water containing air or other gases.

For increasing water pressure from flooded suction applications.

As pressure boosting pump for central water systems with low pressure (follow local specifications if increasing network pressure).

For garden use.

For washing with a jet of water.

Operating conditions

Liquid temperature: 0 °C to +35 °C.

Ambient temperature up to +40 °C.

Suction lift up to 9 m.

Maximum permissible pressure in the pump casing: 8 bar.

Continuous duty.

Motor

2-pole induction motor, 50 Hz ($n \approx 2800$ rpm).

NGX: three-phase 230/400 V \pm 10%.

NGXM: single-phase 230 V \pm 10%, with thermal protector.
Capacitor inside the terminal box.

Insulation class F.

Protection IP 54.

Classification scheme IE3 for three-phase motors from 0,75 kW.

Constructed in accordance with: EN 60034-1; EN 60034-30-1.
EN 60335-1, EN 60335-2-41.

Special features on request

- Other voltages.

- Frequency 60 Hz (as per 60 Hz data sheet).

Materials

Component	Material
Pump casing	Cr-Ni steel 1.4301 EN 10088 (AISI 304)
Casing cover	Cr-Ni steel 1.4301 EN 10088 (AISI 304)
Impeller	Brass P-Cu Zn 40 Pb 2 UNI 5705 (PPO-GF20 (Noryl) for NGX 2/80,3/100,4/110)
Wear ring impeller-diffuser	Cr-Ni steel 1.4301 EN 10088 (AISI 304)
Diffuser	PPO-GF20 (Noryl)
Ejector	PPO-GF20 (Noryl)
Shaft	Chrome steel 1.4104 EN 10088 (AISI 430) Cr-Ni steel 1.4305 EN 10088 (AISI 303) for NGX 6
Mechanical seal	Carbon - Ceramic - NBR

Characteristic curves $n \approx 2800$ rpm

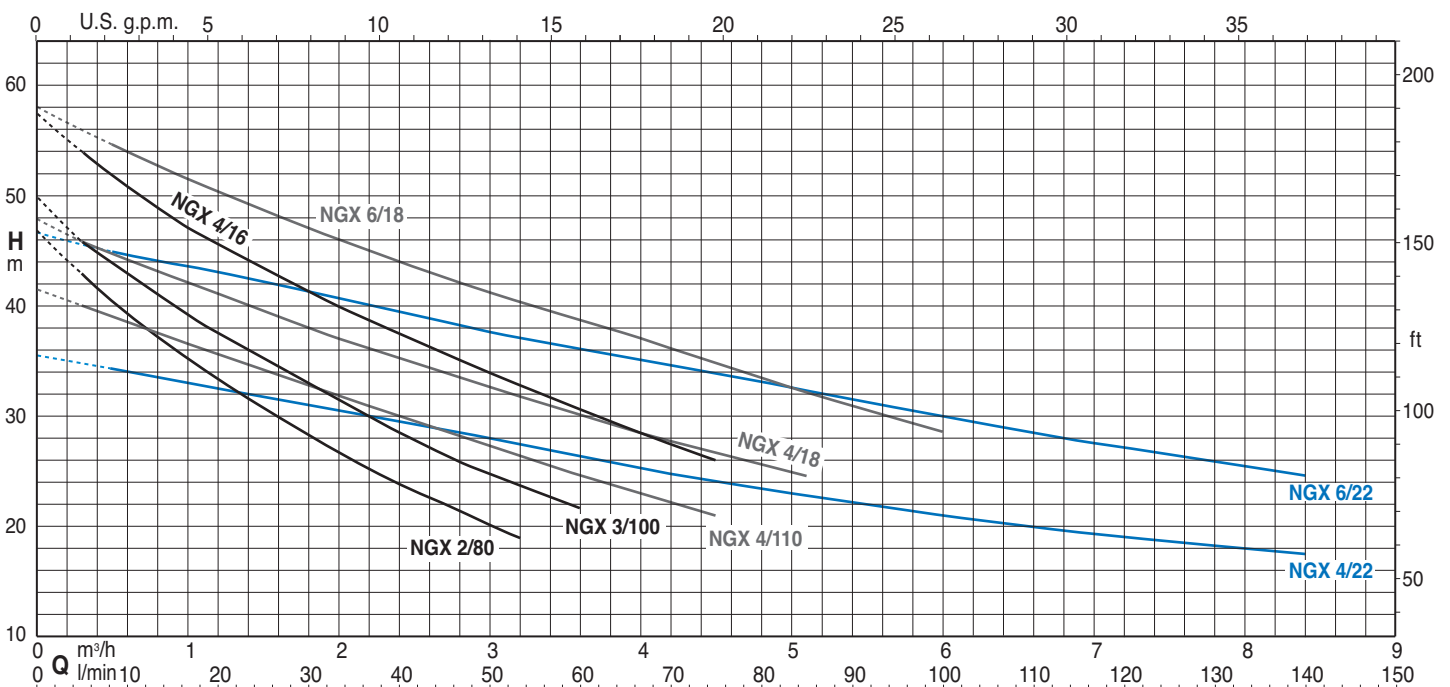

Performance $n \approx 2800$ rpm

3~	230V 400V		1~	230V P1		P2		Q	H											
	A	A		A	kW	kW	HP		m ³ /h	l/min	0	0,3	1	2	2,4	3	3,2	3,6	4	4,5
NGX 2/80	2,8	1,6	NGXM 2/80	3,8	0,8	0,55	0,75	H m	46,8	43	35,2	26,7	23,9	20,2	19,1					
NGX 3/100	3	1,7	NGXM 3/100	4,5	0,95	0,65	0,9		50	45,9	39,4	31,3	28,5	24,8	23,7	21,7				
NGX 4/110	3,7	2,2	NGXM 4/110	5,4	1	0,75	1		41,6	40	36,6	31,9	30	27,3	26,4	24,6	23	21,1		

3~	230V 400V		1~	230V P1		P2		Q	H																	
	A	A		A	kW	kW	HP		m ³ /h	l/min	0	0,5	1	2	2,4	3	4	4,5	5	5,5	6	6,5	7	8	8,4	
NGX 4/16	4,5	2,6	NGXM 4/16	7	1,6	1,1	1,5	H m	57,5	54	47,3	40	37,5	34	28,5	26										
NGX 4/18	4,5	2,6	NGXM 4/18	7	1,6	1,1	1,5		48	46	42,5	37	35	32,5	28,5	27	25									
NGX 4/22	4,5	2,6	NGXM 4/22	7	1,6	1,1	1,5		35,5	34,8	33	30,5	29,5	28	25,3	24	23	22	21	20,3	19,5	18	17,5			
NGX 6/18/A	7,5	4,3	NGXM 6/18	9,2	2	1,5	2		58	54,7	51,5	46	44	41,3	37	34,7	32,5	30,5	28,5							
NGX 6/22/A	7,5	4,3	NGXM 6/22	9,2	2	1,5	2		46,5	45	43,5	40,5	39,3	37,5	35	33,5	32,5	31,2	30	28,5	27,5	25,5	24,5			

P1 Max. power input. P2 Rated motor power output.

Tolerances according to UNI EN ISO 9906:2012

Characteristic curves for different suction lifts Hs

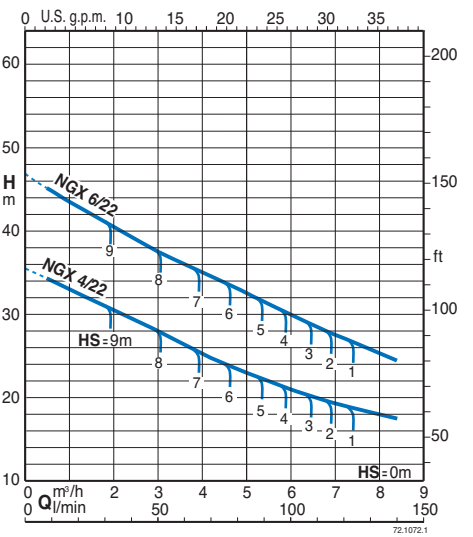
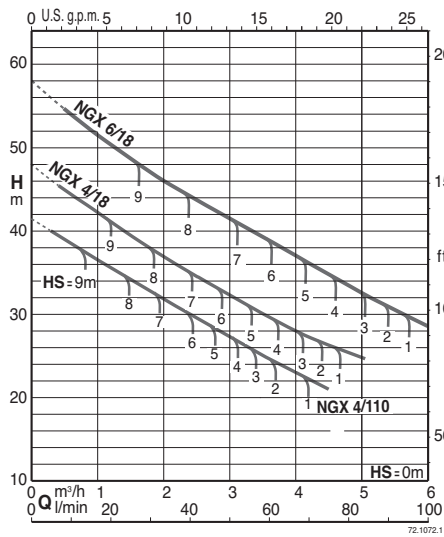
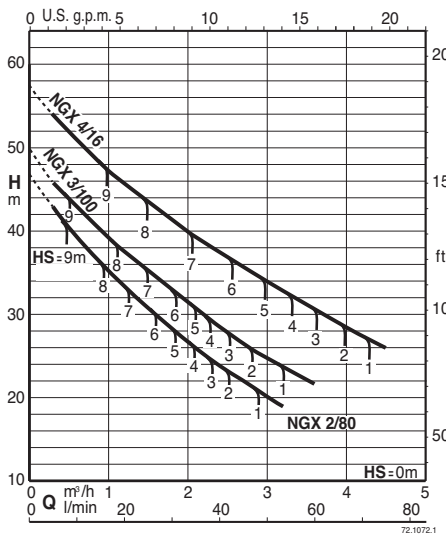

Self-priming capability

50 Hz ($n \approx 2800$ 1/min), H₂O, T = 20°C, Pa = 1000 hPa (mbar)

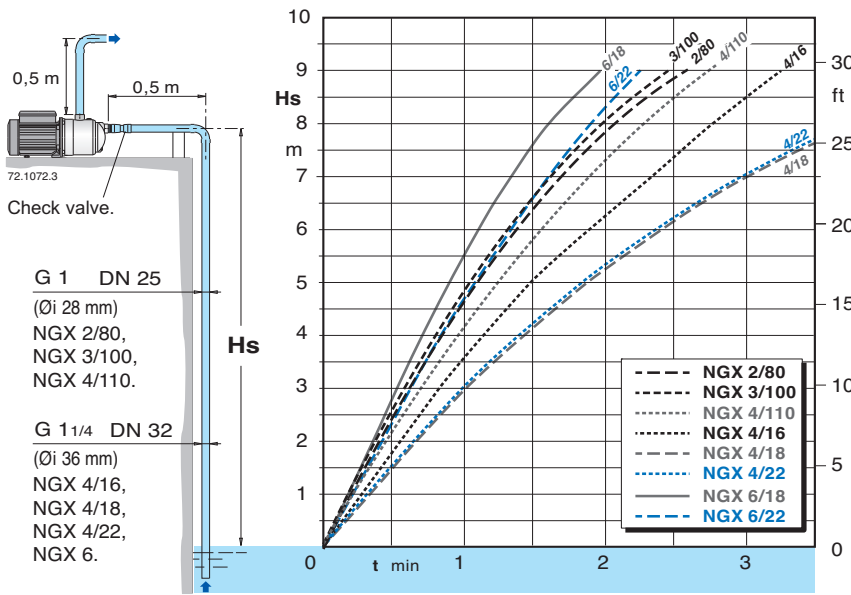

Dimensions and weights

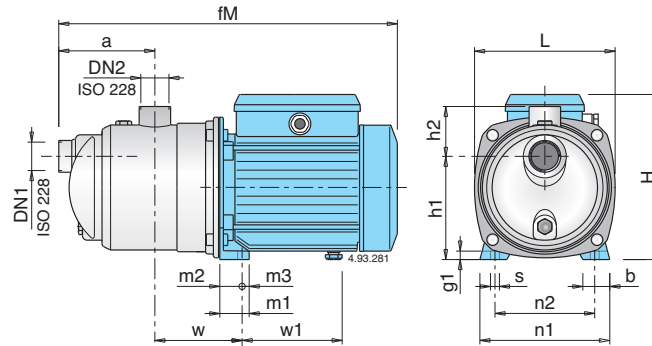

TYPE	DN1 ISO 228	DN2 ISO 228	Dimensions mm															Net weight kg		
			fM	a	w	h1	h2	H	L	m1	m2	m3	n1	n2	b	s	g1	w1	NGX	NGXM
NGX 2/80			362					176										102	6,9	7,1
NGX 3/100	G 1	G 1	391	115	95	116	61	192	161	33	25	8	146	112	30	9	10	112	8,3	9,2
NGX 4/110			391					192										112	10,2	10,2
NGX 4/16																				
NGX 4/18	G 1 1/4	G 1	462	140	113	152	68	225	213,5	37,5	28	9,5	185	155	33	9,5	11	147	14,5	14,8
NGX 4/22																				
NGX 6/18/A	G 1 1/4	G 1	488,5	140	113	152	68	240	213,5	37,5	28	9,5	185	155	33	9,5	11	157,5	17,8	18,2
NGX 6/22/A																				

Features

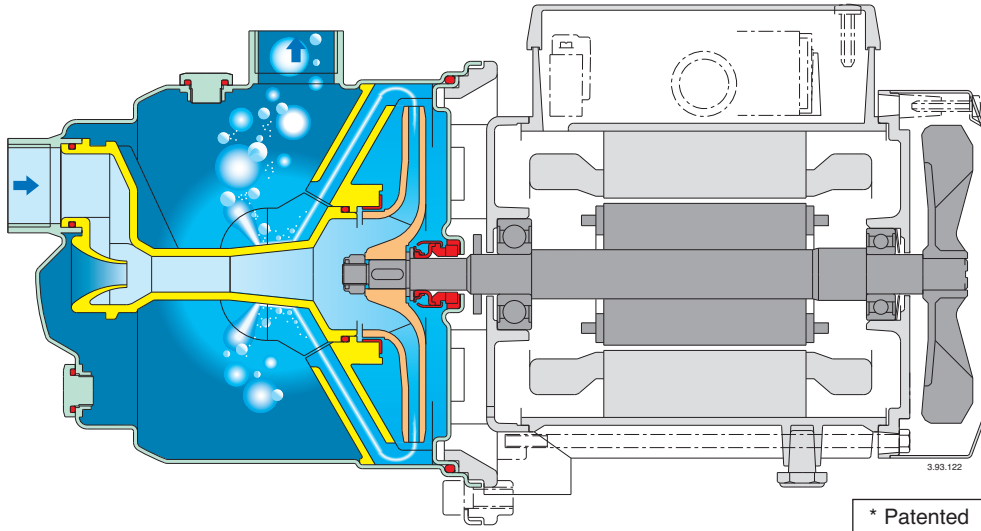

A different pump with new features

An exclusive diffuser design with flow control device* provides for compact construction, fast self-priming capability and low noise.

Reliable

With new design features the NGX is more robust and forgiving when temporary abnormal operating conditions may exist.

Compact

The NGX is smaller than conventional pumps of a similar type, allowing for installation in restricted spaces and providing for easier retrofit applications.

Safe

Fast air evacuation reduces the risk of air-pockets developing at the mechanical seal preventing the danger of seal failure due to a lack of flushing and cooling.

Better self-priming

The NGX are capable of lifting water from depths of 9 m in less than 4 minutes, offers new possibilities on suction lift applications and provides better trouble free service on normal shallow-well suction lift duties, also with a long suction pipe above the water level.

Low noise

The new diffuser and flow control device* guide the fluid from the impeller into the central part of the pump casing, reducing turbulence and velocity, with effective use of the surrounding liquid in dampening the noise of flow.